

REFRIGERATOR MANUFACTURER
Turbo air

Commercial Refrigerator & Freezer Service Manual

Solid Door

Model No.: TSR-23SD
TSR-49SD
TSR-72SD
TSF-23SD
TSF-49SD
TSF-72SD

TABLE OF CONTENTS

1. FEATURE CHART

- 1-1. FRONT VIEW
- 1-2. SIDE VIEW

2. WIRING DIAGRAM

- 2-1. REFRIGERATOR (1DOOR) : TSR-23SD
- 2-2. FREEZER (1DOOR) : TSF-23SD
- 2-3. REFRIGERATOR (2DOOR) : TSR-49SD
- 2-4. FREEZER (2DOOR) : TSF-49SD
- 2-5. REFRIGERATOR (3DOOR) : TSR-72SD
- 2-6. FREEZER (3DOOR) : TSF-72SD

3. PART DETAILS

- 3-1. TOP GRILLE
- 3-2. REFRIGERATION COMPARTMENT
- 3-3. ELECTRICAL BOX
- 3-4. DOOR
- 3-5. COOLING COMPARTMENT

4. MAIN COMPONENTS

- 4-1. COMPRESSOR
- 4-2. COMPRESSOR RELAY
- 4-3. CONDENSER DRYER
- 4-4. CAPACITOR
- 4-5. EVA FAN MOTOR
- 4-6. CONDENSOR FAN MOTOR
- 4-7. EVA DEFROST HEATER
- 4-8. LAMP
- 4-9. PCB TRANSFORMER
- 4-10. MAIN PCB

5. ELECTRONIC CONTROLLER INSTRUCTION

- 5-1. FREEZER CONTROLLER
 - 5-1-1. HOW TO USE THE PANEL
 - 5-1-2. FUNCTION TABLE
 - 5-1-3. ERROR CODE TABLE
- 5-2. REFRIGERATOR CONTROLLER
 - 5-2-1. HOW TO USE THE PANEL
 - 5-2-2. FUNCTION TABLE
 - 5-2-3. ERROR CODE TABLE

6. SPARE PARTS LIST

7. REPLACEMENT OF MAIN COMPONENTS

- 7-1. TOP GRILLE PARTS
- 7-2. REPLACING DOOR
- 7-3. REFRIGERATION COMPARTMENT'S PARTS
- 7-4. CONDENSING UNIT
- 7-5. REPLACING CABINET FRAME HEATER (AND/OR) MULLION HEATER

1. FEATURE CHART

1-1. FRONT VIEW

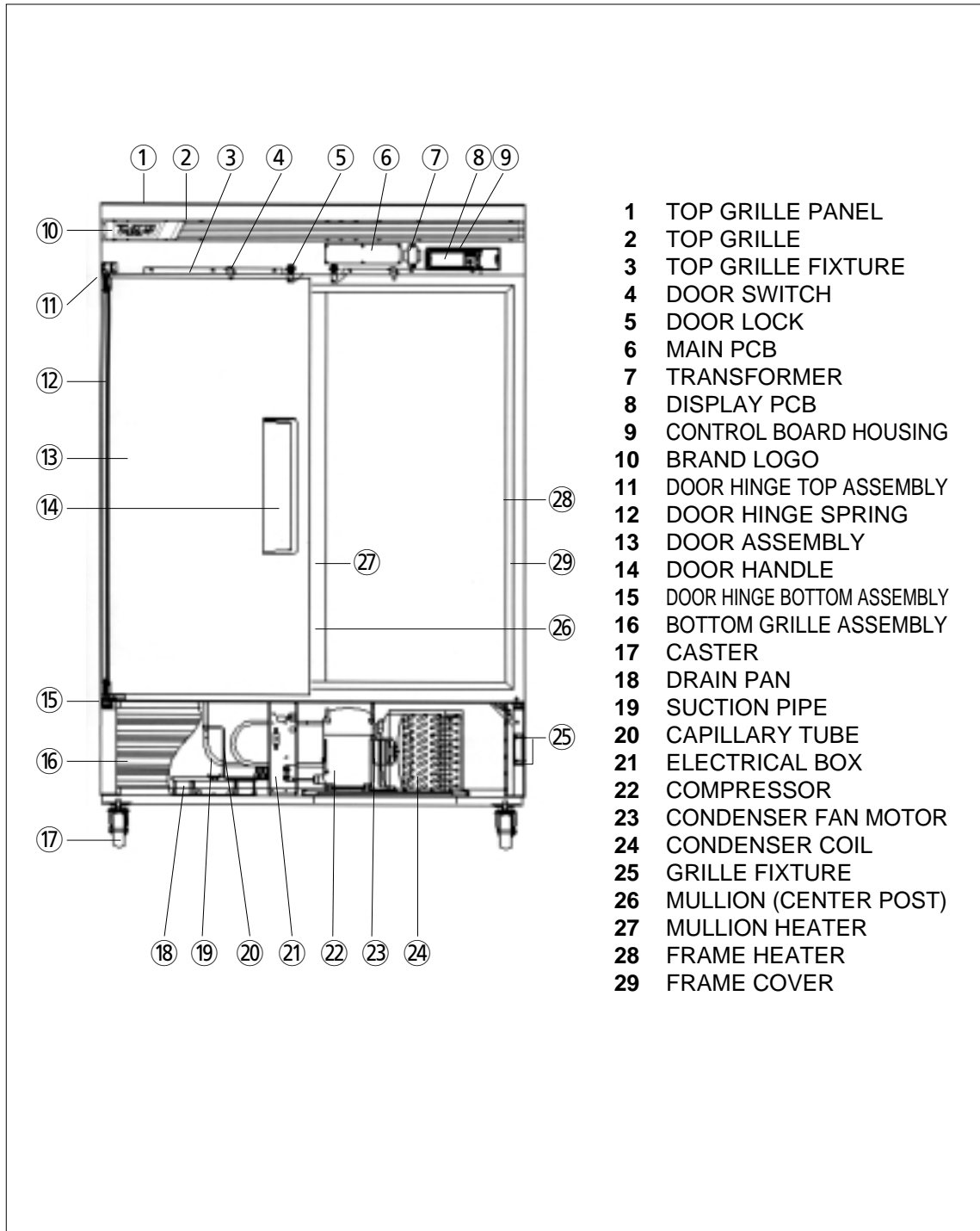

FEATURE CHART

1-2. SIDE VIEW

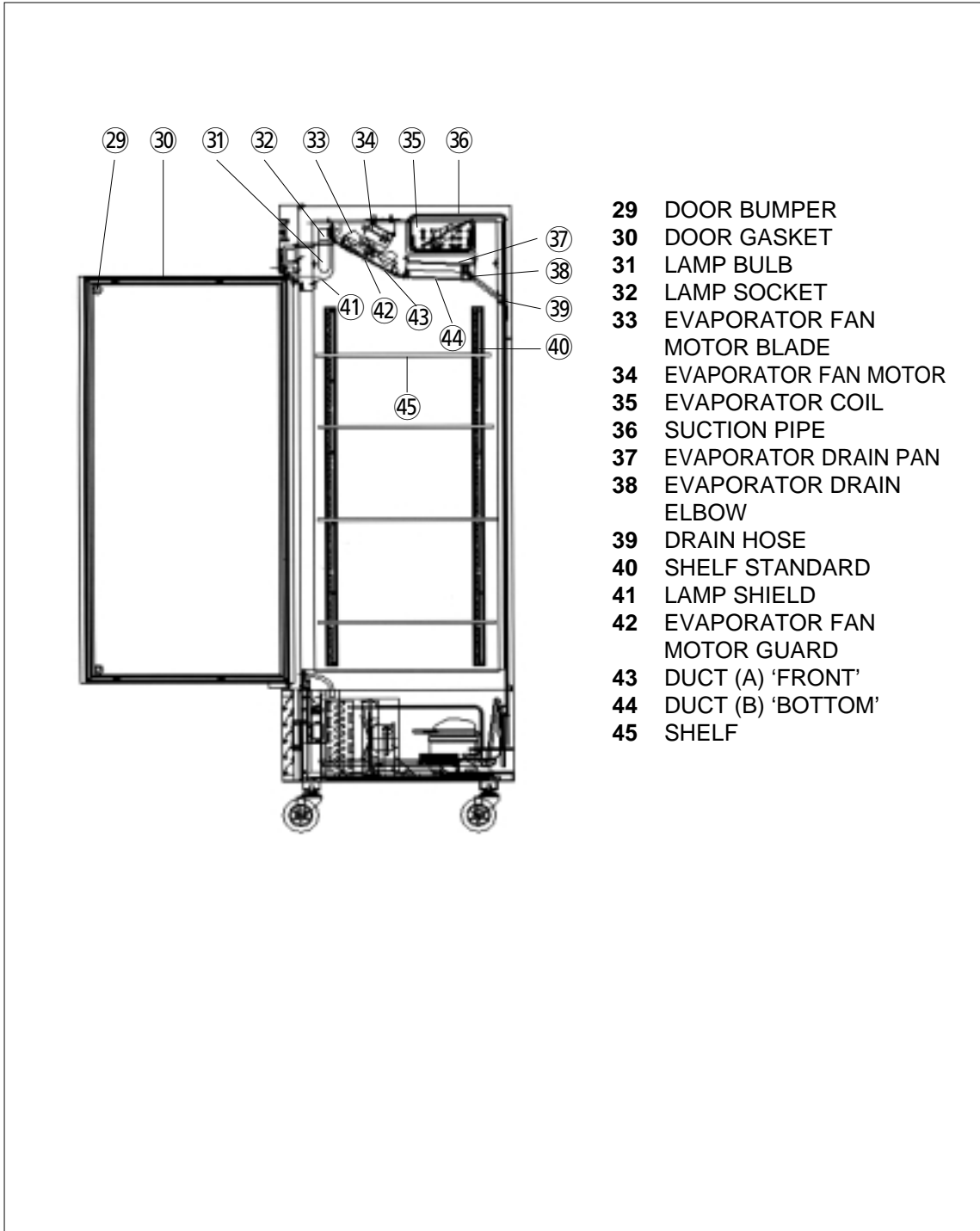

- 29 DOOR BUMPER
- 30 DOOR GASKET
- 31 LAMP BULB
- 32 LAMP SOCKET
- 33 EVAPORATOR FAN MOTOR BLADE
- 34 EVAPORATOR FAN MOTOR
- 35 EVAPORATOR COIL
- 36 SUCTION PIPE
- 37 EVAPORATOR DRAIN PAN
- 38 EVAPORATOR DRAIN ELBOW
- 39 DRAIN HOSE
- 40 SHELF STANDARD
- 41 LAMP SHIELD
- 42 EVAPORATOR FAN MOTOR GUARD
- 43 DUCT (A) 'FRONT'
- 44 DUCT (B) 'BOTTOM'
- 45 SHELF

2. WIRING DIAGRAM

2-1. TSR-23SD

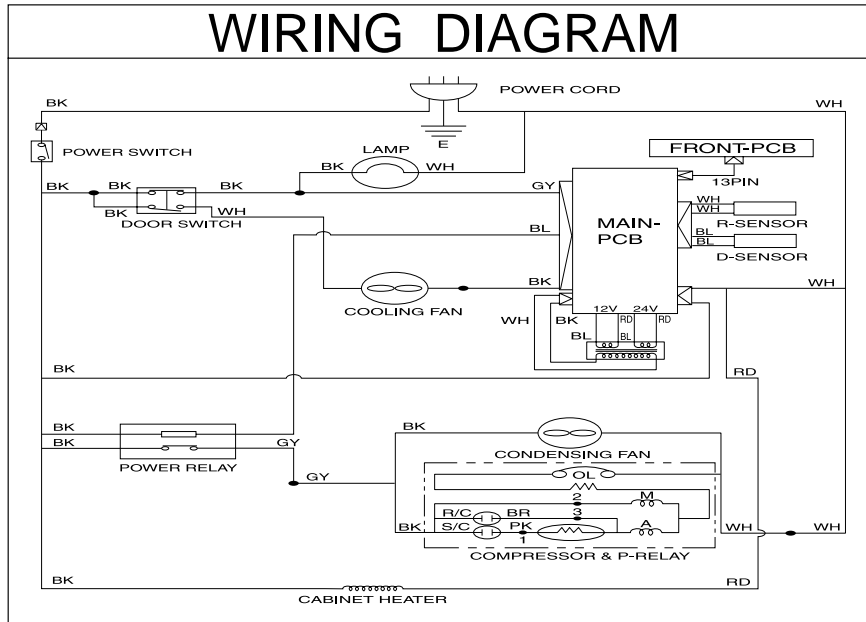

2-2. TSF-23SD

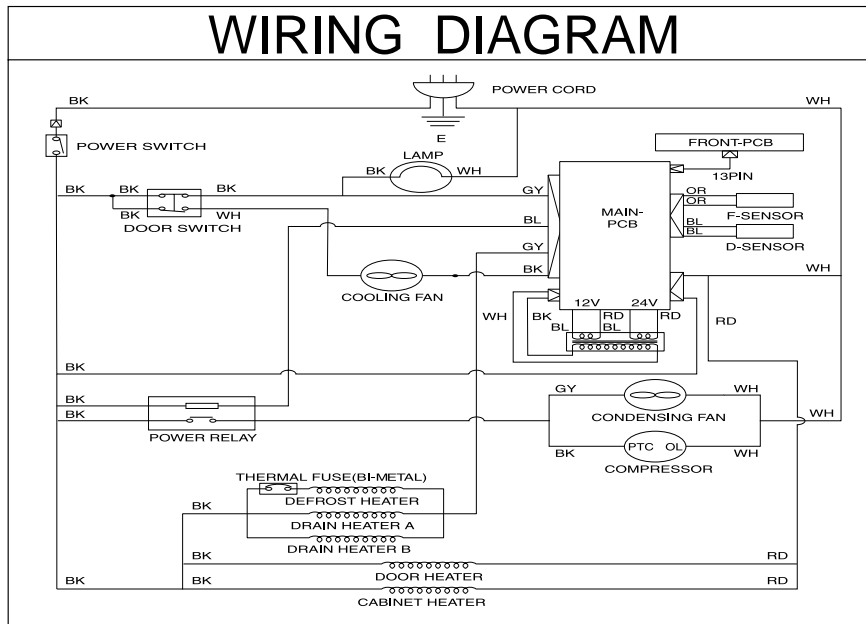

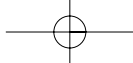

WIRING DIAGRAM

2-3. TSR-49SD

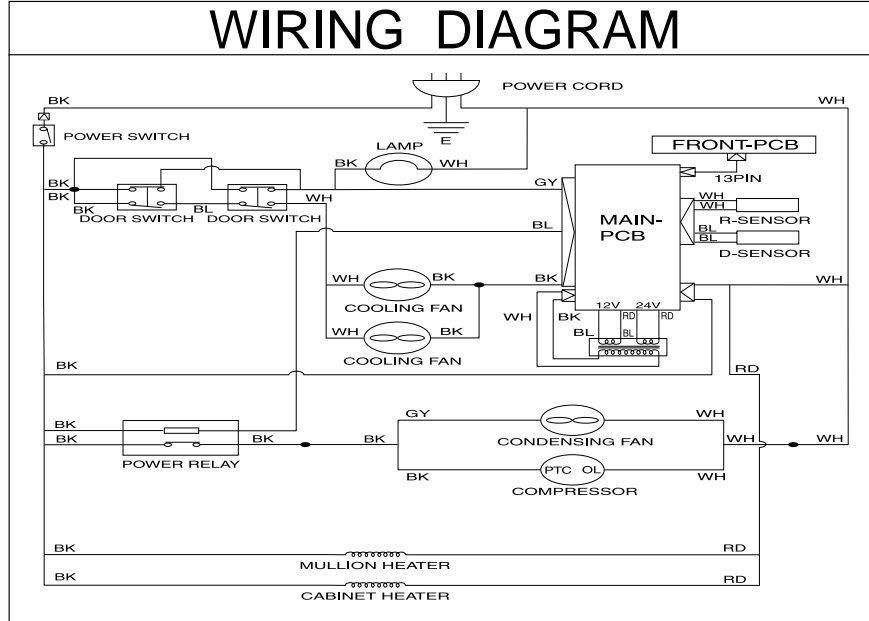

2-4. TSF-49SD

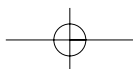
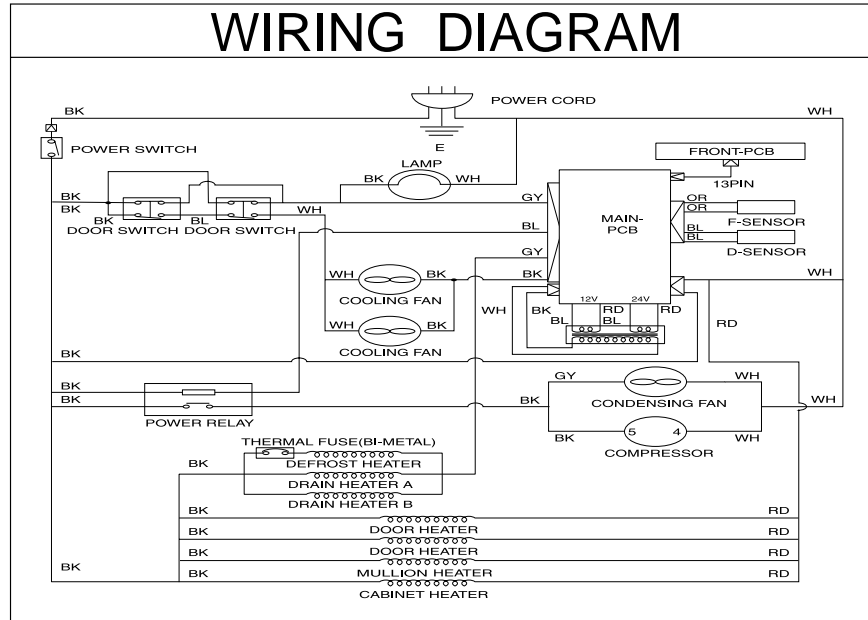

WIRING DIAGRAM

2-5. TSR-72SD

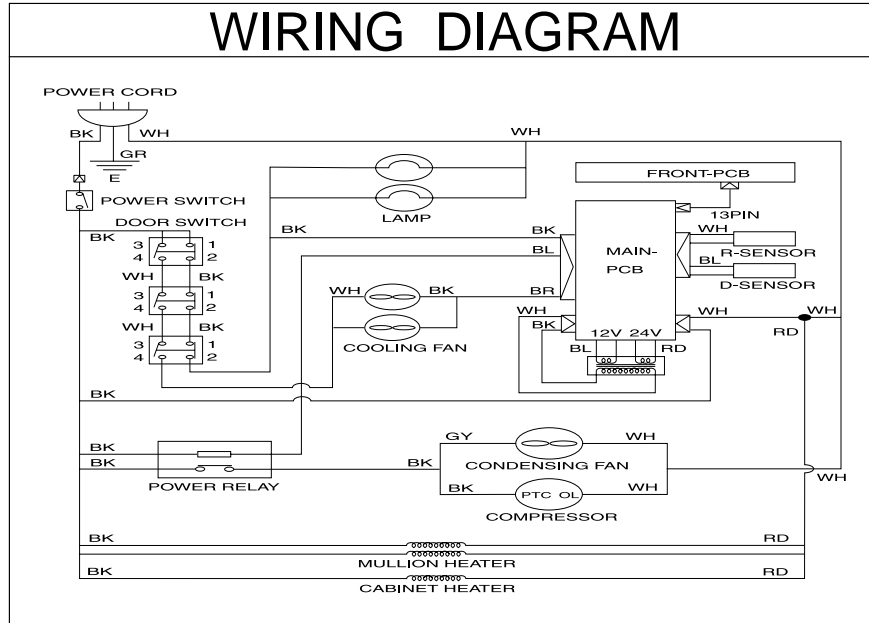

2-6. TSF-72SD

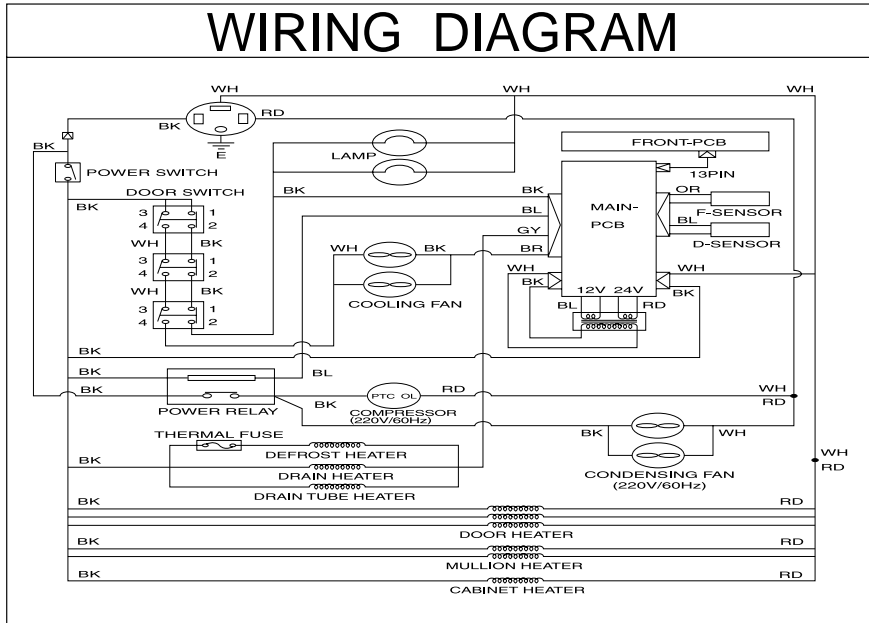

3. PART DETAILS

3-1. TOP GRILLE

Door Lock, Switch



Transformer, Main P.C.B

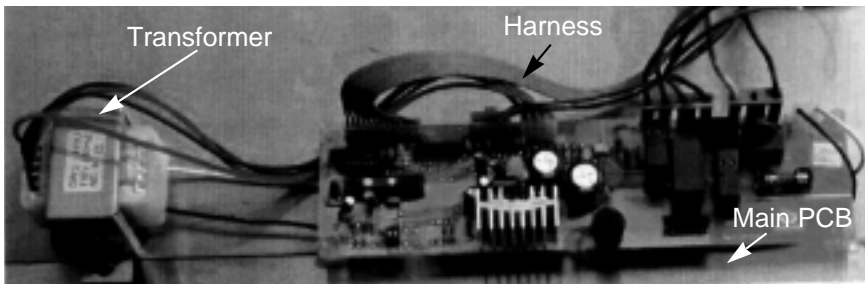

3-2. Refrigeration Compartment

Cycle Assembly

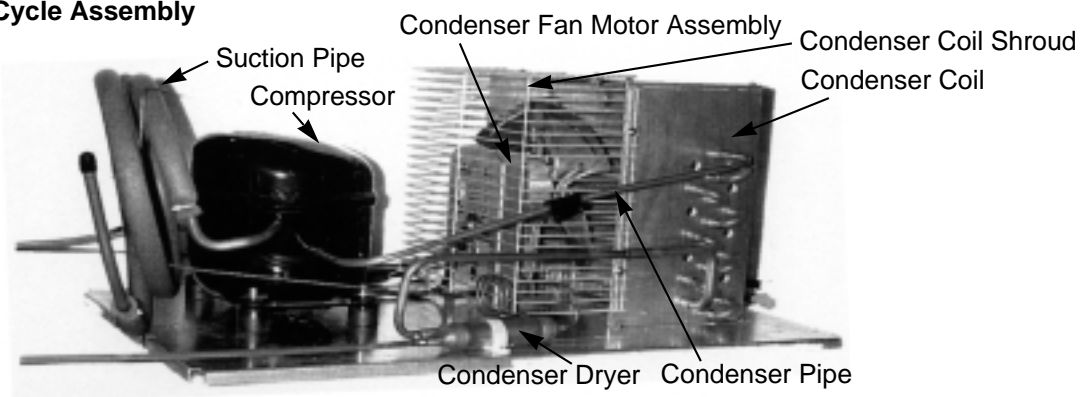

PART DETAILS

Drain Pan Assembly

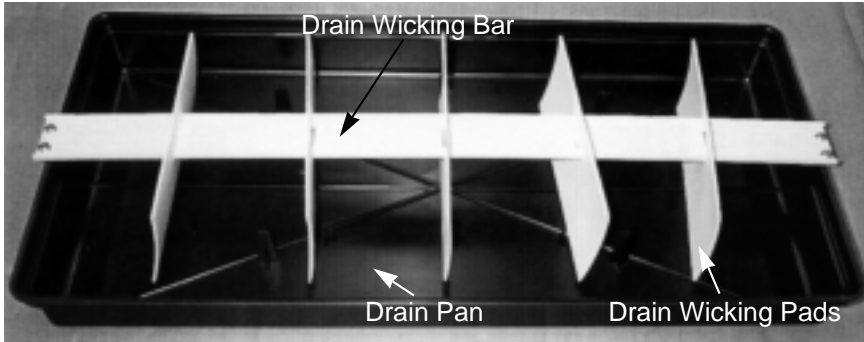

Condenser Fan Motor Assembly

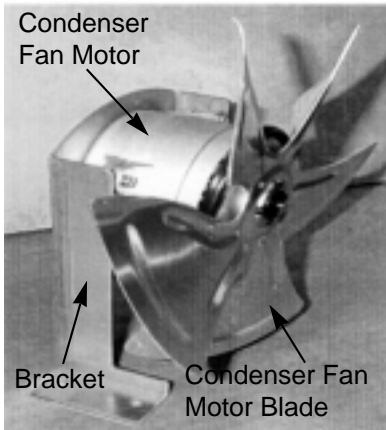

3-3. Electrical Box

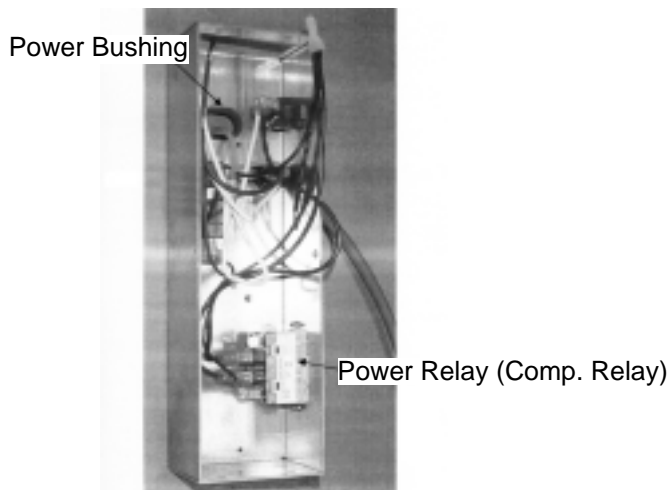

3-4. Door

Gasket

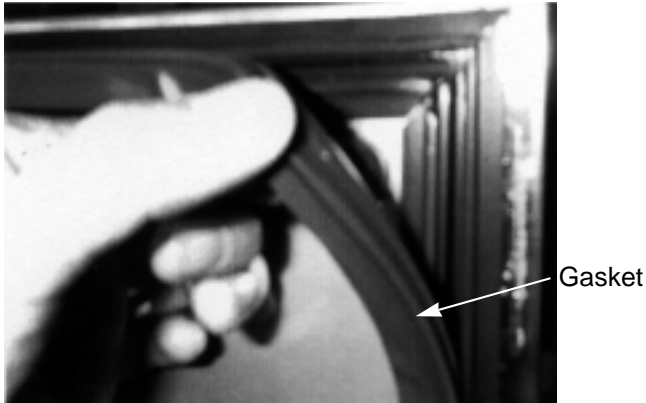

3-5. Cooling Compartment

Freezer Duct & Refrigerator Duct (TSR-49SD, TSF-49SD, TSR-72SD, TSF-72SD Type)

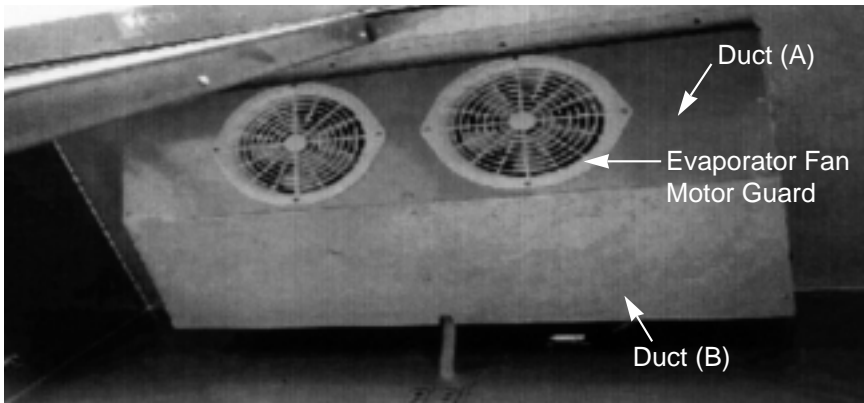

Freezer Evaporator, Fan (TSF-49SD, TSF-72SD)

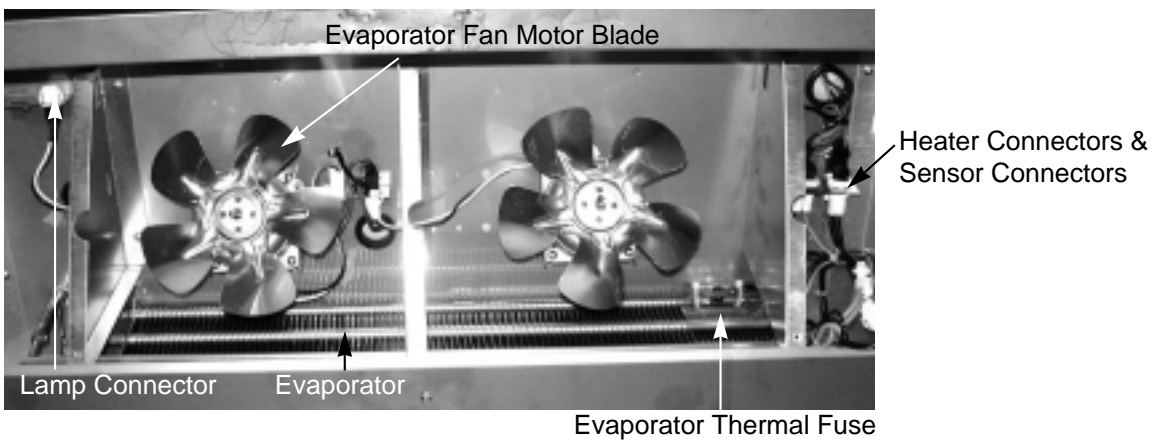

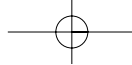

PART DETAILS

Freezer Duct & Refrigerator Duct (TSR-23SD, TSF-23SD Type)

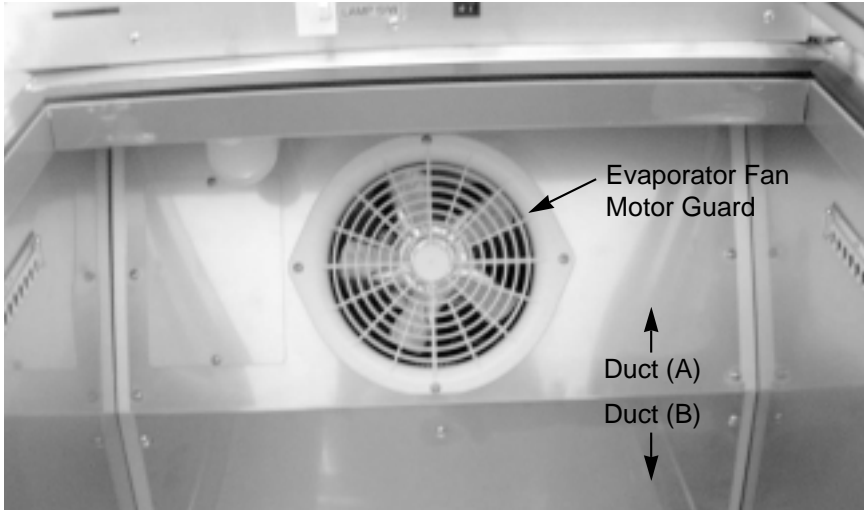

Freezer Evaporator, Fan (TSF-23SD)

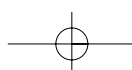
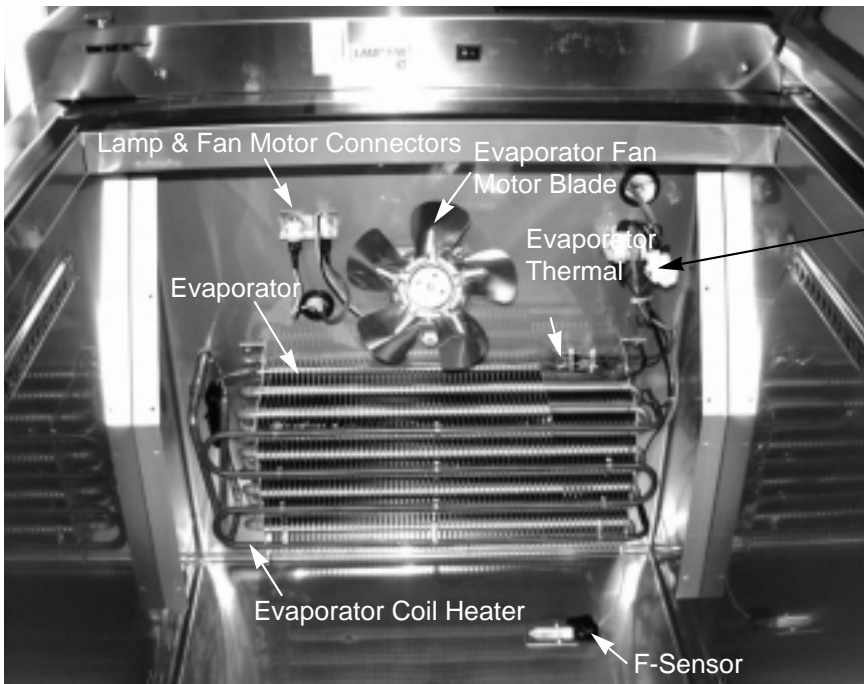

4. MAIN COMPONENTS

4-1. COMPRESSOR

Model	TSR-23SD	TSR-49SD	TSF-23SD	TSF-49SD	TSR-72SD	TSF-72SD
Refrigerant	R-134a		R-404a		R-134a	R-404a
Voltage	115V / 60Hz					208/230
Comp. Model	HBL27YE-1	SK6A1C-H2Y	AEA2411ZXA	AJA2425ZXA	AKA4476YXA	CAJ2446Z
Part code	3952127G10	3020014540	30200L0100	30200L0200	30200A4700	30206Q3600
Strating type	CSR	RSIR	CSIR	CSIR	CSIR	CSR

4-2. COMPRESSOR RELAY

Model	TSR-23SD	TSR-49SD	TSF-23SD	TSF-49SD	TSR-72SD	TSF-72SD
Voltage	115V / 60Hz					220V/60Hz
Relay Model	783RHBZZ-52	4TM811XHB-53	8300MRTL13	8300CRAN04	8300MRAM53	3ARR3-3A3A

4-3. CONDENSER DRYER

Model	TSR-23SD	TSR-49SD	TSF-23SD	TSF-49SD	TSR-72SD	TSF-72SD
Refrigerant	R-134a		R-404a		R-134a	R-404a
Spec.	XH-9(50g)					
Part code	30268L0300		30268L0400		30268Q0100	30268Q0210

4-4. CAPACITOR

Model	TSR-23SD	TSR-49SD	TSF-23SD	TSF-49SD	TSR-72SD	TSF-72SD
Voltage	115V / 60Hz					220V/60Hz
Running	230V/10uF	x	x	370V/15uF	x	440V/15μF
Part code	400EL15130	Comp.Assembly				
Starting	200V/100uF	x	165V/270~324uF	330V/161~193uF	378~445MFD	260V/88μF
Part code	401RD35050	Comp.Assembly				

MAIN COMPONENTS

4-5. EVA FAN MOTOR

Model	TSR-23SD	TSR-49SD	TSF-23SD	TSF-49SD	TSR-72SD	TSF-72SD
Voltage	115V / 60Hz					
Motor Model	IS4420DWSN-2A					
Part code	3963328120					

4-6. CONDENSOR FAN MOTOR

Model	TSR-23SD	TSR-49SD	TSF-23SD	TSF-49SD	TSR-72SD	TSF-72SD
Voltage	115V / 60Hz					220V/60Hz
Motor Model	IS4420DWSG-1					IS4420DWSQ-1
Part code	3963220410					3963322020

4-7. EVA DEFROST HEATER

Model	TSR-23SD	TSR-49SD	TSF-23SD	TSF-49SD	TSR-72SD	TSF-72SD
Voltage	115V / 60Hz					
Spec.	x		445W	600W	x	900W
Part code	x		30228L0802	30228L0700	x	30228Q0600

4-8. LAMP BULB

Model	TSR-23SD	TSR-49SD	TSF-23SD	TSF-49SD	TSR-72SD	TSF-72SD
Voltage	120V / 60Hz					
Spec.	25W					
Part code	30236L0100					

4-9. TRANSFORMER

Model	TSR-23SD	TSR-49SD	TSF-23SD	TSF-49SD	TSR-72SD	TSF-72SD
Voltage	115V / 60Hz					
Spec.	DWS-115U					
Part code	30284L0100					

4-10. MAIN PCB

Model	TSR-23SD	TSR-49SD	TSF-23SD	TSF-49SD	TSR-72SD	TSF-72SD
Voltage	115V / 60Hz					
Part code	30243L0310		30243L0200	30243L0300	30243L0310	30243Q0300
Micom code	1RF1151		1FF1153	2FF1153	1RF1151	3FF1151

* Last digit of micom code represents micom version.
It may be changed without notice.

6. PART-LIST OF SOLID DOOR MODEL

Part name	Code	Material	Description	Model									
				R-23S	R-49S	F-23S	F-49S	R-72S	F-72S				
Caster													
CASTER	30265L0200		TP5040-22-HDP	2	2	2	2	3	3				
CASTER BRAKE	30265L0100		TP5040-22-HDP-TLB	2	2	2	2	3	3				
Compressor													
COMPRESSOR RUN CAPACITOR	400EL15130		230V/10 μ F	1									
COMPRESSOR START CAPACITOR	401RD35050		200V/100 μ F	1									
COMPRESSOR	3952127G10		HBL27YE-1	1									
COMPRESSOR	3020014540		SK6A1C-H2Y		1								
COMPRESSOR	30200L0100		AEA2411ZXA			1							
COMPRESSOR	30200L0200		AJA2425ZXA				1						
COMPRESSOR	30200A4700		AKA4476YXA					1					
COMPRESSOR	30206Q3600		CAJ2446Z							1			
COMPRESSOR POWER CORD (RELAY HARNESS)	30200L3400		INCLUDED PTC, OL	1									
COMPRESSOR POWER CORD (RELAY HARNESS)	30227Q1400										1		
COMPRESSOR POWER CORD (RELAY HARNESS)	30227L0502						1	1					
COMPRESSOR POWER CORD (RELAY HARNESS)	30227L0602				1								
COMPRESSOR POWER CORD (RELAY HARNESS)	30227L2800					1							
POWER RELAY (COMP. RELAY)	8536490000		G7L-1A-TUB(OMRON)	1	1	1	1	1	1	1			
ELECTRICAL BOX HARNESS	30227L1711			1									
ELECTRICAL BOX HARNESS	30227L0802				1	1	1	1					
ELECTRICAL BOX HARNESS	30227Q1100										1		
MAIN POWER CORD	30213A1010		125V, 15A	1	1	1	1	1					
MAIN POWER CORD	30213Q0201		115V, 30A								1		
Condenser													
CONDENSER COIL	30200L4001			1									
CONDENSER COIL	30200L4201				1								
CONDENSER COIL	30200L4101					1							
CONDENSER COIL	30200L4302						1	1					
CONDENSER COIL	30200Q3500										1		
CONDENSER COIL SHROUD	30214L4500			1	1								
CONDENSER COIL SHROUD	30214L4600					1	1	1					
CONDENSER COIL SHROUD	30214Q2800										1		
CAPILLARY TUBE	30244Q0300	C1220T	L=950 ID ϕ 1.2	1									
CAPILLARY TUBE	30244L1302	C1220T	L950 ID ϕ 1.2		1	1							
CAPILLARY TUBE	30244Q0400	C1220T	L3378 ID ϕ			1							
CAPILLARY TUBE	30244L1402	C1220T	L4425 ID ϕ 2.0				1						

PART-LIST OF SOLID DOOR MODEL

Part name	Code	Material	Description	Model					
				R-23S	R-49S	F-23S	F-49S	R-72S	F-72S
CAPILLARY TUBE (A)	30244Q1000	C1220T	L2263 IDø3.56					1	1
CAPILLARY TUBE (B)	30244Q1100	C1220T	L3505 IDø2.0						1
CONDENSER DRYER	30268L0300	C1220T	XH-9 50g ø3.1	1	1				
CONDENSER DRYER	30268L0400	C1220T	XH-9 50g ø3.5			1	1		
CONDENSER DRYER	30268Q0100	C1220T	XH-9 50g ø5.0					1	
CONDENSER DRYER	30268Q0210	C1220T	XH-9 50g ø5.0						1
Condenser Fan									
CONDENSER FAN MOTOR BLADE	30218B0100	AL	ø225	1	1				2
CONDENSER FAN MOTOR BLADE	30218A0100	AL	ø250			1	1	1	
CONDENSER FAN MOTOR	3963220410		IS-4420DWSG-1	1	1	1	1	1	
CONDENSER FAN MOTOR	3963322020		IS-4420DWSQ-1						2
Door									
DOOR BUSHING	3007H1000		PA-6	2	4	2	4	3	3
DOOR ASSEMBLY	30200L3100			1					
DOOR ASSEMBLY	30200L2900					1			
DOOR ASSEMBLY(LEFT)	30200L2600				1			1	
DOOR ASSEMBLY(LEFT)	30200L2400						1		1
DOOR ASSEMBLY(MIDDLE)	30200Q2320							1	
DOOR ASSEMBLY(RIGHT)	30200L2700				1			1	
DOOR ASSEMBLY(RIGHT)	30200L2500						1		1
DOOR ASSEMBLY(MIDDLE)	30200Q2330								1
DOOR GASKET	30223L0211	PVC-S		1	2	1	2	3	3
DOOR HINGE SPRING	30251L0100		ø3.4	1	2	1	2	3	3
CABINET FRAME HEATER	30228L0111	45W		1		1			
CABINET FRAME HEATER	30228L0203	60W			1		1		
CABINET FRAME HEATER	30228Q0100	75W	L=6700mm					1	1
MULLION COVER	30214Q2500	STS430			1		1	2	2
MULLION HEATER	30228L0903	20W	L=2520mm		1		1		
MULLION HEATER	30228Q0300	25W	L=2520mm					1	1
DOOR HINGE TOP ASSEMBLY LEFT	30229L0800	SPCC, T3.0	MFZN (WH)		1		1	1	1
DOOR HINGE TOP ASSEMBLY RIGHT	30229L0900	SPCC, T3.0	MFZN (WH)	1	1	1	1	2	2
DOOR HINGE BOTTOM ASSEMBLY LEFT	30229L0100	SPCC, T5.0	MFZN (WH)		1		1	1	1
DOOR HINGE BOTTOM ASSEMBLY RIGHT	30229L0200	SPCC, T5.0	MFZN (WH)	1	1	1	1	2	2
Drain									
DRAIN PAN	30211L0700	HIPS		1		1			

PART-LIST OF SOLID DOOR MODEL

Part name	Code	Material	Description	Model						
				R-23S	R-49S	F-23S	F-49S	R-72S	F-72S	
DRAIN PAN	30211J0103	HIPS			1		1	1	1	
DRAIN WICKING BAR	30230J0700	PVC-H			1		1	1	1	
DRAIN WICKING BAR	30230L0100	PVC-H		1		1				
DRAIN WICKING PADS	30245L1000	PULP	T2.5	5		5				
DRAIN WICKING PADS	30245A0700	PULP	T2.5		5		5	5	5	
Evaporator										
DRAIN CAP	30209L0200	PA-6		1	1	1	1	1	1	1
EVAPORATOR DRAIN PAN	30211L0501	A1100P-H14	0.8T, WH PAINTING	1		1				
EVAPORATOR DRAIN PAN	30211L0601	A1100P-H14	0.8T, WH PAINTING		1		1			
EVAPORATOR DRAIN PAN	30211Q0100	A1100P-H14	0.8T, WHPAINTING					1	1	
EVAPORATOR COIL	30270L0500					1				
EVAPORATOR COIL	30270L0600						1			
EVAPORATOR COIL	30270L0101			1						
EVAPORATOR COIL	30270Q0200							1		
EVAPORATOR COIL	30270L0202				1					
EVAPORATOR COIL	30270Q0100								1	
THERMO PIPE	30244L2410			1	1				1	
EVAPORATOR SENSOR	30227Q1200		F-Sensor, D-Sensor			1	1			1
EVAPORATOR SENSOR	30227Q1300		R-Sensor, D-Sensor	1	1				1	
DRAIN PAN FIXTURE	30220L0502	A5052P-H14		1	1	1	1	1	1	1
EVAPORATOR THERMAL FUSE	30272L0400	250V/7.5A	PST-3(80/10)			1	1			1
EVAPORATOR DRAIN ELBOW	30225L0100	PA-6		1	1	1	1	1	1	1
EVAPORATOR DEFROST HEATER	30228L0802	SUS304, ø8	445W			1				
EVAPORATOR DEFROST HEATER	30228L0700	SUS304, ø8	600W				1			
EVAPORATOR DEFROST HEATER	30228Q0600	SUS304, ø8	900W							1
EVAPORATOR DRAIN PAN HEATER	30228L1400	90W	L=6,225mm			1				
EVAPORATOR DRAIN PAN HEATER	30228Q0500	90W	L=8,290m							1
EVAPORATOR DRAIN PAN HEATER	30228L1500	90W	L=9,335mm				1			
DRAIN HOSE HEATER	30228L1310	10W	L=700mm			1	1			1
DRAIN PAN INSULATOR	30233L0100	E-PS		1		1				
DRAIN PAN INSULATOR	30233L0200	E-PS			1		1			
DRAIN PAN INSULATOR	30233Q0100	E-PS						1	1	
EVAPORATOR FAN MOTOR GUARD	30214K0100	ABS		1	2	1	2	2	2	2
EVAPORATOR FAN MOTOR BLADE	30218F0200	AL	ø175	1	2	1	2	2	2	2
EVAPORATOR FAN MOTOR	3963328120		IS-4420DWSN-2A	1	2	1	2	2	2	2

PART-LIST OF SOLID DOOR MODEL

Part name	Code	Material	Description	Model						
				R-23S	R-49S	F-23S	F-49S	R-72S	F-72S	
DUCT (A)	30269L0304	SUS 304		1		1				
DUCT (A)	30269L0404	SUS 304			1		1			
DUCT (A)	30269Q0500	SUS 304						1	1	
DUCT (B)	30269L0507	SUS 304		1		1				
DUCT (B)	30269L0606	SUS 304			1		1			
DUCT (B)	30269Q0400	SUS 304							1	1
Top Grille Panel										
TOP GRILLE PANEL ASSEMBLY	30224L0450			1						
TOP GRILLE PANEL ASSEMBLY	30224L0230				1					
TOP GRILLE PANEL ASSEMBLY	30224L0350					1				
TOP GRILLE PANEL ASSEMBLY	30224L0130						1			
TOP GRILLE PANEL ASSEMBLY	30200Q3800								1	
TOP GRILLE PANEL ASSEMBLY	30200Q4000									1
TOP GRILLE PANEL	30224L0304	STS304-HL		1		1				
TOP GRILLE PANEL	30224L0104	STS304-HL			1		1			
TOP GRILLE PANEL	30200Q3900	STS304-HL							1	1
TOP GRILLE	30216Q0100	ABS	BLACK	1		1				
TOP GRILLE	30216Q0200	ABS	BLACK		1		1			
TOP GRILLE	30216Q0300	ABS	BLACK						1	1
BRAND LOGO	30242Q0500		BLACK, HOT-STAMP	1	1	1	1	1	1	1
PCB HARNESS	30227L1001			1	1	1	1	1	1	1
FRONT LABEL	30235Q0900	PC, T0.254		1	1				1	
FRONT LABEL	30235L0100	PC, T0.254				1	1			1
DOOR LOCK(KEY)	30238G0100			1	2	1	2	3	3	
CONTROL BOARD HOUSING	30242L0100		BLACK, HOT-STAMP	1	1	1	1	1	1	1
DISPLAY PCB	30243Q0100			1	1				1	
DISPLAY PCB	30243L0100			1						
MAIN PCB	30243L0300						1			
MAIN PCB	30243L0310			1	1				1	
MAIN PCB	30243L0200					1				
MAIN PCB	30243Q0300									1
POWER SWITCH (ROCKER SWITCH)	30281Q0100		125V/15A	1	1	1	1	1	1	1
DOOR SWITCH	30281L0100		SP201R-10D	1	2	1	2	3	3	
TRANSFORMER	30284L0100		DWS-115U	1	1	1	1	1	1	1
Bottom Grille										
BOTTOM GRILLE ASSEMBLY	30224L1410	STS304-HL		1		1				

PART-LIST OF SOLID DOOR MODEL

Part name	Code	Material	Description	Model						
				R-23S	R-49S	F-23S	F-49S	R-72S	F-72S	
BOTTOM GRILLE ASSEMBLY	30224L1400	STS304-HL			1		1			
BOTTOM GRILLE ASSEMBLY	30200Q4100	STS304-HL						1	1	
Lamp										
LAMP SHIELD	30214L3200	PP	MILKY	1	1	1	1	2	2	
LAMP HARNESS	30227L0900			1	1	1	1	2	2	
LAMP BULB	30236L0100		25W/120V	1	1	1	1	2	2	
LAMP SOCKET	30279L0100	MEDIUM BASE	L-124B-PVC	1	1	1	1	2	2	
Shelf										
SHELF STANDARD	30220L1001	STS304-2B	0.8T, L=48"	4	8	4	8	4	4	
SHELF CLIP	30220L0900	PA-6		12	24	12	24	36	36	
SHELF	30278Q0100	STS304		3		3				
SHELF	30278Q0200	STS304			6		6	9		
SHELF	30278Q0210	STS304							9	
SHELF STANDARD (REAR POST ASSEMBLY)	30245Q0400	AL+STS	L=51.5"					2	2	
SHELF STANDARD (FRONT POST ASSEMBLY)	30245Q0410	AL+STS	L=50"					2	2	
COLD AIR FLOW GUIDE WIRE	30269Q0600	PE							6	

7. REPLACEMENT OF MAIN COMPONENTS

7-1. TOP GRILLE PARTS

- MAIN PCB or TRANSFORMER
- DISPLAY PCB
- DOOR LOCK or POWER SWITCH (ROCKER SWITCH)
- DOOR SWITCH

A. Unscrew the screw located both sides of top grille panel.



REPLACEMENT OF MAIN COMPONENTS

B. Unscrew the screws located on top of top grille panel.



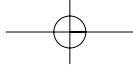

REPLACEMENT OF MAIN COMPONENTS

C. Unscrew the screws located on bottom of top grille panel.

* Caution : When unscrewing, hold the top grille panel.
Falling down top grille may cause bruise.



D. Place the top grille panel on the top of the cabinet.



E. You can replace PCB, Transformer.

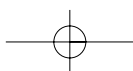

REPLACEMENT OF MAIN COMPONENTS

F. Pull out the harness located back of top grille panel.

You can separate top grille panel.

You can replace power switch(rocker switch), door switches(lamp switch) and control board housing.



G. To re-assemble, do reversed in order.

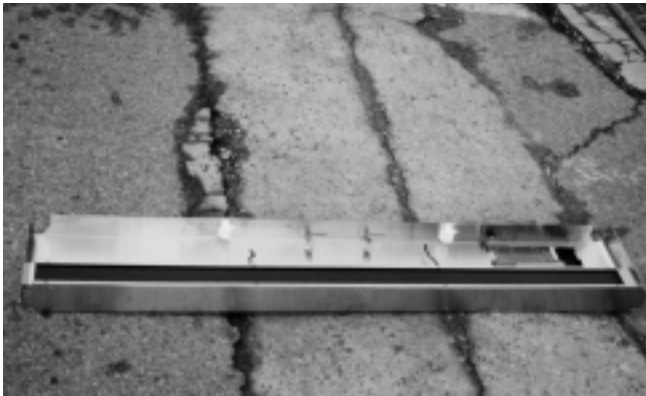

REPLACEMENT OF MAIN COMPONENTS

7-2. REPLACING DOOR

- A. Disassemble top grille panel as described section 7-1 A.B.C.D.
- B. Remove Bottom Grille by unscrewing the four screws located on each side of the Bottom Grille.



- C. Open the electrical box. Then uncap the door heater wire. (Freezer model only)

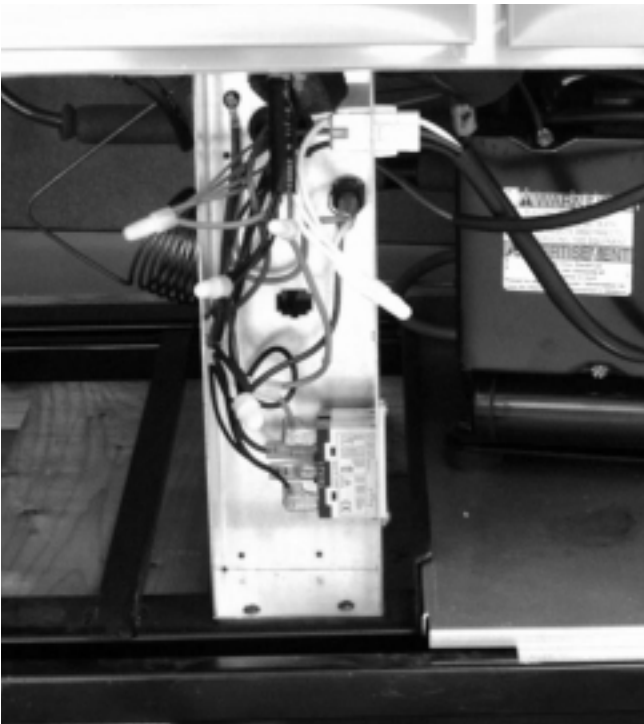

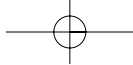

REPLACEMENT OF MAIN COMPONENTS

D. The figure of the disassembled top grille panel.



E. Unscrew the hinge.



F. Unscrew the last screw with pushing the hinge.



G. After unscrewing, the hinge will rotate about 90°(CCW), of itself.

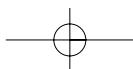
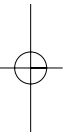
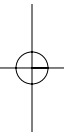

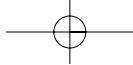

REPLACEMENT OF MAIN COMPONENTS

H. Lift the door and pull out the door heater's lead wire.



I. Replace the door with the new one.

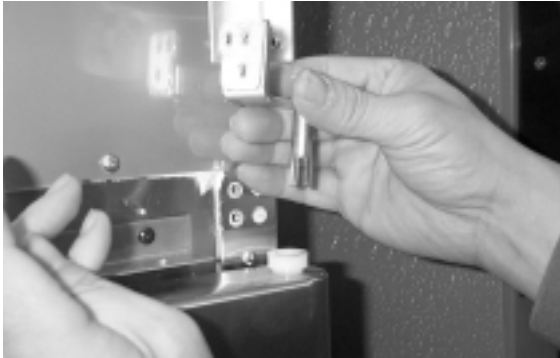

J. Ready the hinge as below. It is important to set initial position (angle).

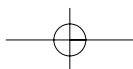
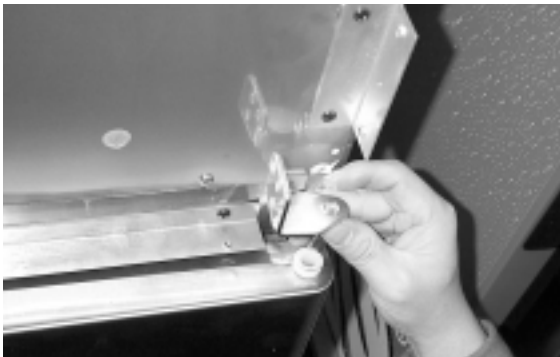

REPLACEMENT OF MAIN COMPONENTS

K. Initial position of the hinge must be as below.

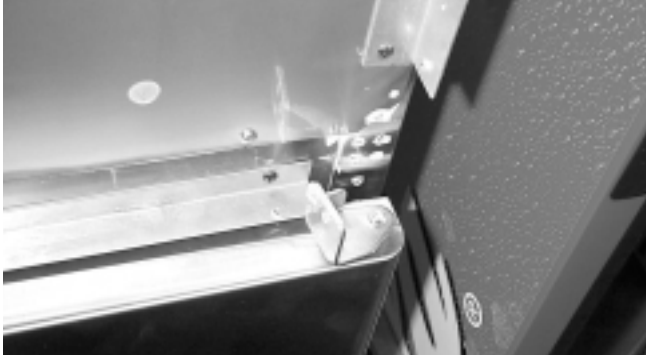

L. Turn the hinge 90° CW. This turning causes torsion strength of the bar spring that shuts the door(s) automatically.



M. Screw the hinge with pushing it. After installation of the door(s), assemble the top grille panel.



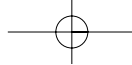

REPLACEMENT OF MAIN COMPONENTS

7-3. REFRIGERATION COMPARTMENT'S PARTS

A. Disassemble lamp shield.

- LAMP BULB or LAMP SHIELD
- EVAPORATOR FAN MOTOR
- F/D SENSOR or R/D SENSOR
- EVAPORATOR DEFROST HEATER
- EVAPORATOR COIL



B. Disassemble Duct (A).



C. Pull out the lamp harness.

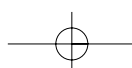
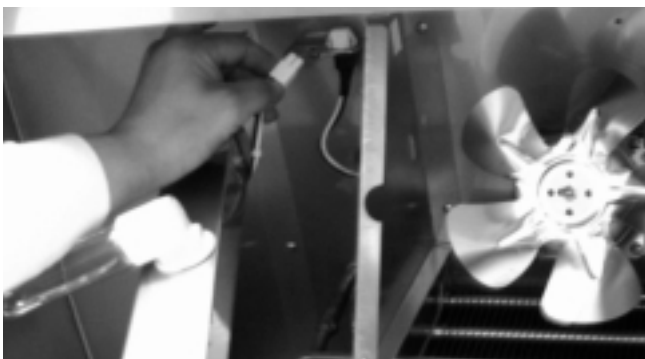

REPLACEMENT OF MAIN COMPONENTS

D. Disassemble duct (B).



E. Pull-out the evaporator drain pan heater's leadwire.

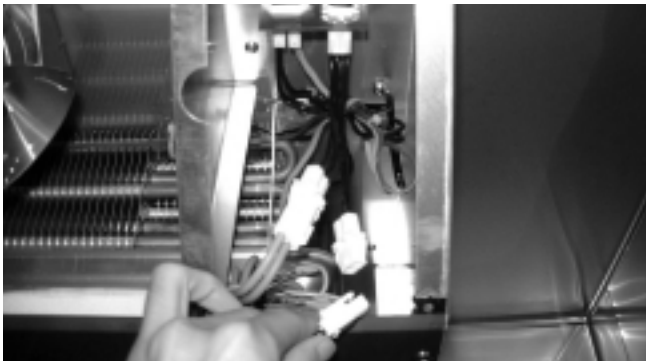

F. Figure of disassembled refrigeration compartments.



In this situation, you can replace fan motor, F/D-sensor, Evaporator coil, ETC.

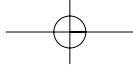

REPLACEMENT OF MAIN COMPONENTS

G. Replacing evaporator fan motor

F-1. Pull out the fan motor's connector.

F-2. Unscrew the four screws which located on bottom of fan motor.



H. Replacing F/D-Sensor or R/D-Sensor

H-1. F-Sensor of Freezer

Unscrew as illustrated below and pull-out the F-Sensor from the cover.

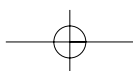
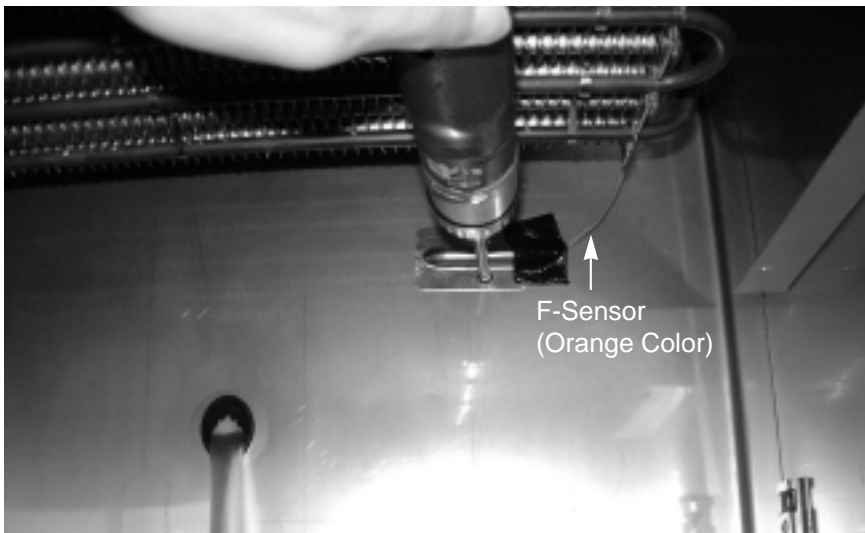

REPLACEMENT OF MAIN COMPONENTS

- H-2. D-Sensor of Freezer (Evaporator Defrost Sensor)
Disassemble the D-Sensor from evaporator's end plate.

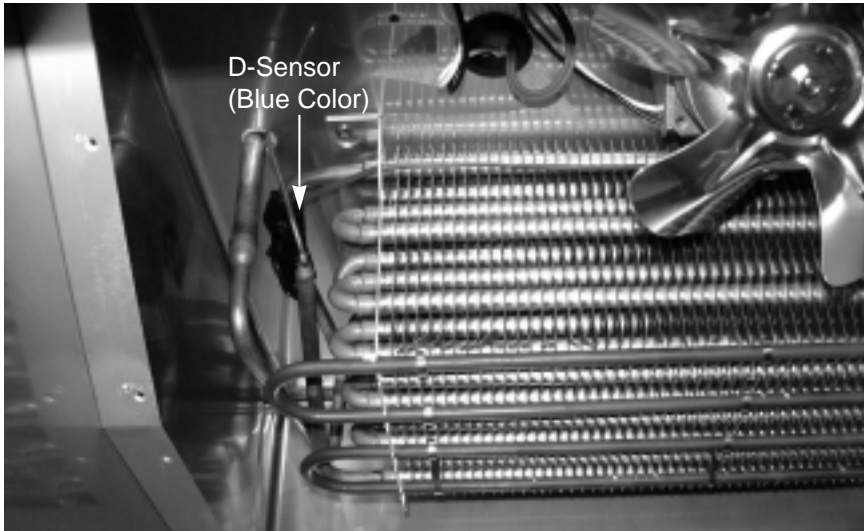

- H-3. R-Sensor of Refrigerator
Unscrew as illustrated below and pull-out the R-Sensor from the cover.

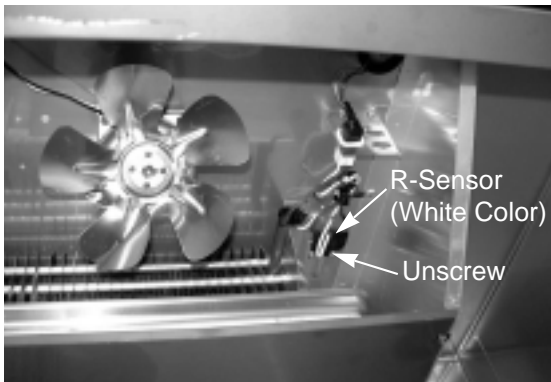

TSR-49SD
TSR-72SD

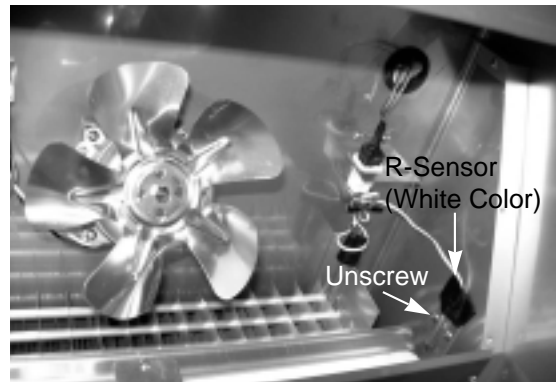

TSR-23SD

REPLACEMENT OF MAIN COMPONENTS

H-4. D-Sensor of Refrigerator

Remove the absorber pad at the end of thermo-pipe and pull-out the D-Sensor.

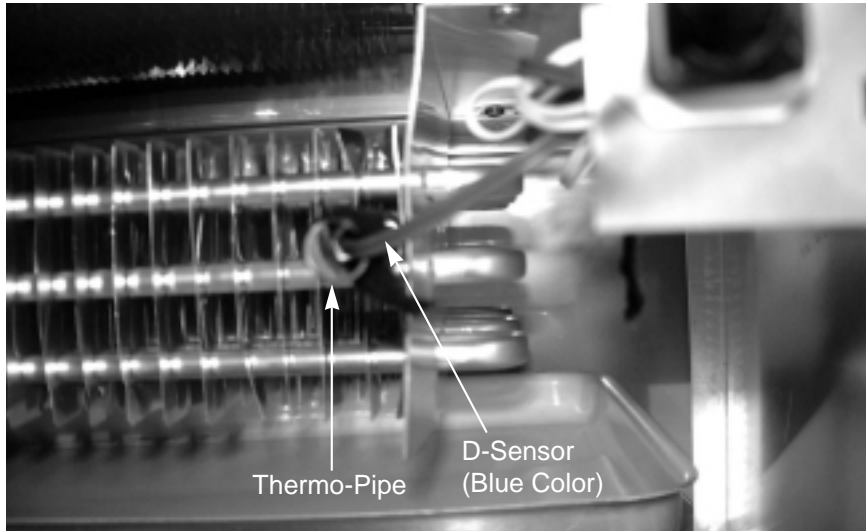

H-5. F/D Sensor or R/D Sensor

After unplug each sensor, pull-out the sensor's lead wire.

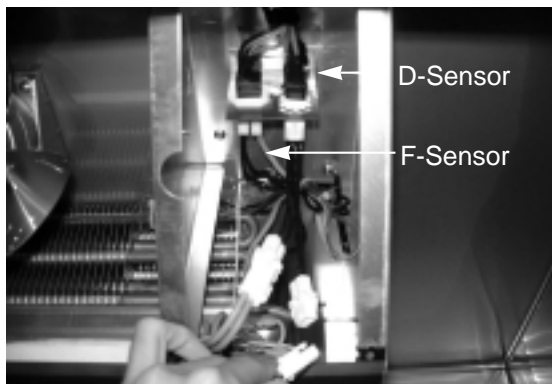

F/D Sensor
(F-Sensor : Orange Color,
D-Sensor : Blue Color)

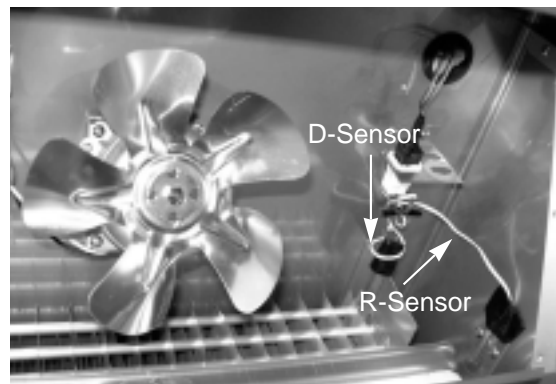

R/D Sensor
(R-Sensor : White Color,
D-Sensor : Blue Color)

REPLACEMENT OF MAIN COMPONENTS**REPLACING EVAPORATOR DEFROST HEATER (FREEZER ONLY)**

A. After disassembling the duct(A) and the duct(B), get ready as below for replacing the evaporator defrost heater.

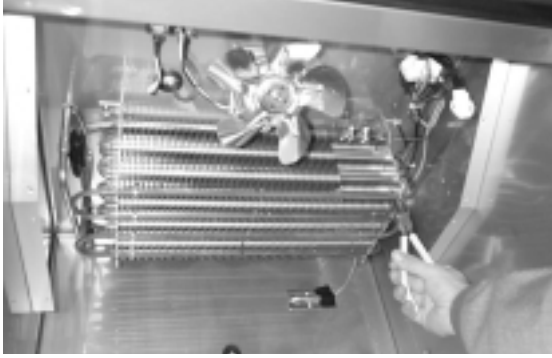

B. Pull out the pins from the bottom of the evaporator using the nipper, etc.

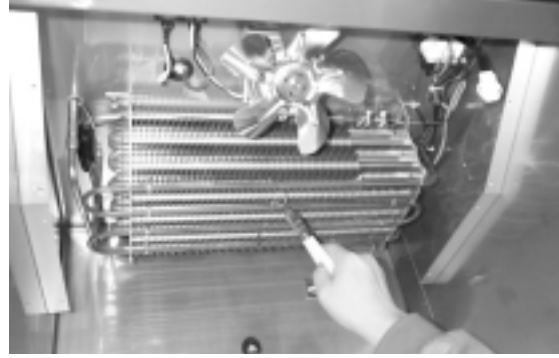

H. Split the hooks of the evaporator.

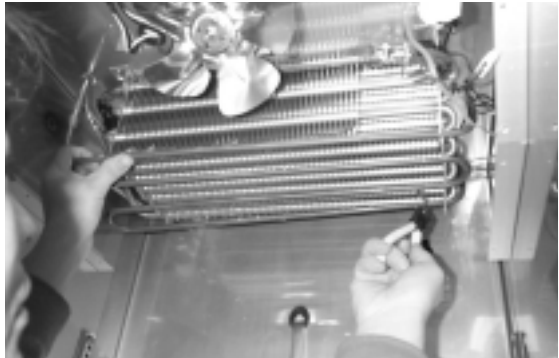

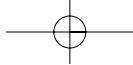

REPLACEMENT OF MAIN COMPONENTS

D. After removing all pins, disconnect the connectors from the thermal fuse and the main



E. Take apart the evaporator defrost heater from the evaporator.

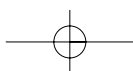

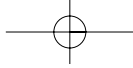

REPLACEMENT OF MAIN COMPONENTS

F. Install the new evaporator defrost heater in original position.



G. Pat the evaporator defrost heater with the soft hammer.

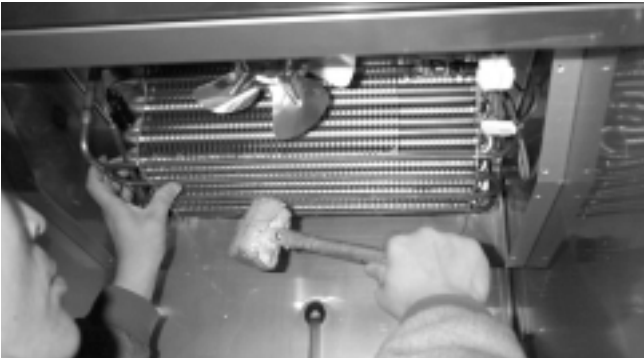

H. Pinch the hooks of the evaporator.

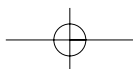
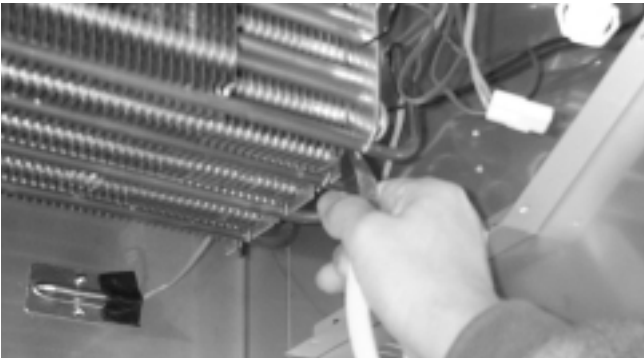

REPLACEMENT OF MAIN COMPONENTS

I. Assemble the pins in original positions.



J. Connect the connectors of the evaporator defrost heater to them of the thermal fuse



* NOTE

Why is always 115 voltage detected between connectors of the evaporator defrost heater in the main harness?

The SNUBBER (located Main PCB) holds two AC power lines simultaneously.

The SNUBBER prevents Main PCB malfunction from sparks occurred by other electrical component's ON/OFF. (SNUBBER = Spark killer)

Because of the SNUBBER, 115 voltage is always detected, but electrical current in this case is very little (small Amps.). So, this electrical current is not enough to operate the evaporator defrost heater.

How to measure the Amps. of the evaporator defrost heater.

Disconnect the connectors of the evaporator defrost heater.

Then, prepare the additional Power Source (115V/60Hz) and the Amp. Meter.

Connect the evaporator defrost heater to the additional power source and read amp. value from the Amp. Meter.

REPLACEMENT OF MAIN COMPONENTS

7-4. CONDENSING UNIT

- Condensing units : Compressor, Condenser Fan Motor, Condenser Coil, Condenser Dryer....
- Others : Compressor Power Cord (Relay harness), Main Power Cord, Electrical Box, ETC.

A. Disassemble Bottom Grille as described section 7-2. B.

B. Unscrew two screws as below.



C. Unplug the compressor's power plug.



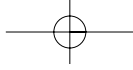

REPLACEMENT OF MAIN COMPONENTS

D. Pull-out the condensing unit.

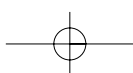
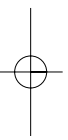
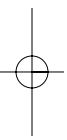

REPLACEMENT OF MAIN COMPONENTS

7-5. REPLACING CABINET FRAME HEATER (and/or) MULLION HEATER

A. Insert the end edge of '-'type screw driver into the gap between the frame and the frame cover.



B. Take apart the frame cover from the frame.



C. Separate the frame cover by sliding the screw driver.



D. Do just like above instructions in other parts (bottom side, right side and top side).



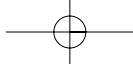

REPLACEMENT OF MAIN COMPONENTS

E. Below picture shows the inlet of the cabinet frame heater toward the electrical box.



F. Uncap connectors of the cabinet frame heater.



G. Pull out the heater wire from the inlet.

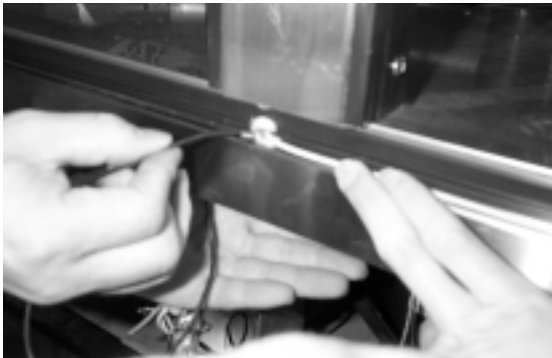

H. Insert the new cabinet frame heater wire to the inlet, after surrounding it along the frame.

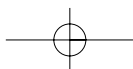

REPLACEMENT OF MAIN COMPONENTS

**I. Assemble the frame cover with the frame.
Push and slide the frame cover toward
corner.**



**J. Fit the end lines of the frame cover each
other.**



K. Fit the other side of the frame cover, too.



**L. Pat the frame cover with the soft
hammer, etc.**



REPLACEMENT OF MAIN COMPONENTS

M. Do like above instructions in other parts (Left side, right side and top side).



REPLACEMENT OF MAIN COMPONENTS

N. Unscrew the screws from the mullion.

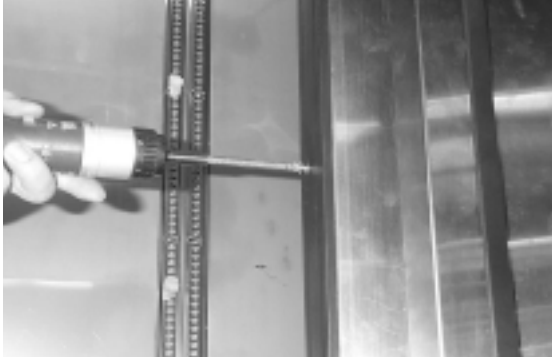

O. Take apart the mullion cover from the mullion.



P. Take care for the mullion heater not to be hurt. (It does not matter, if this heater is out of order).



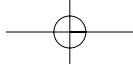

REPLACEMENT OF MAIN COMPONENTS

Q. Pull out the insulator from inside.



R. Uncap connectors of the mullion heater.



S. Pull out the heater wire from the inlet.

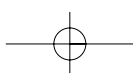
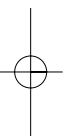
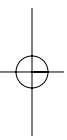
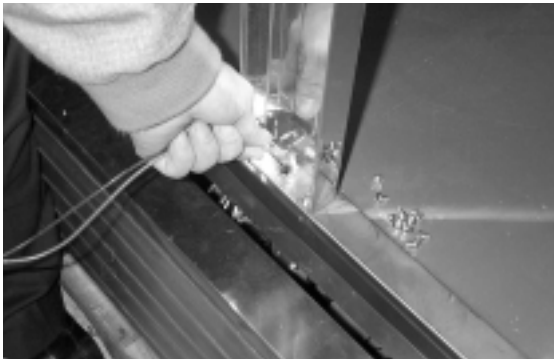

REPLACEMENT OF MAIN COMPONENTS

T. Pull out the mullion cover(SUS) from the mullion cover (ABS).



U. Change the old mullion heater and install the new one with the gap between wires 1.2 inch.

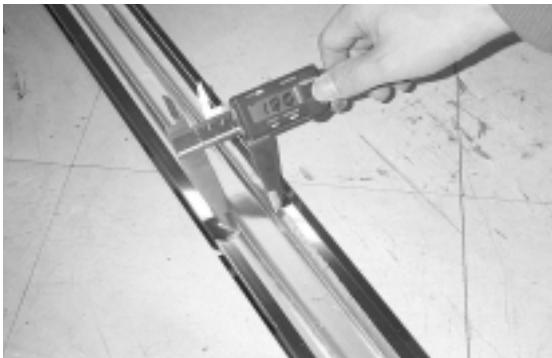

V. Insert the mullion cover(SUS) into the original position.

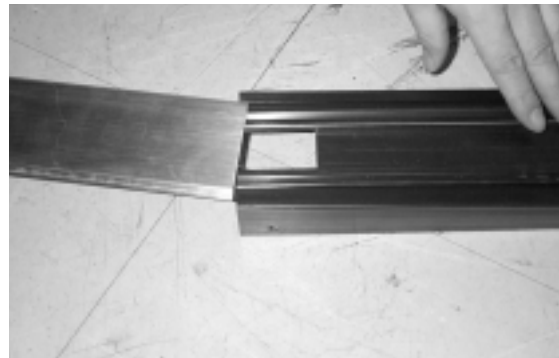

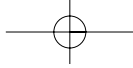

REPLACEMENT OF MAIN COMPONENTS

W. Connect the heater wires with the main harness and the electrical box harness.



X. Cover the caps on the connection parts and press them tightly.

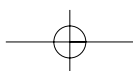
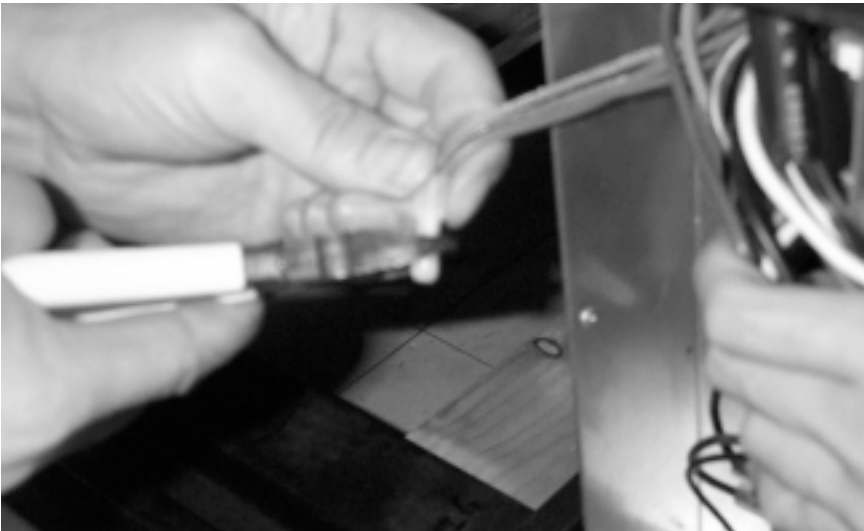

ABOUT THIS MANUAL

VISION CREATIVE, INC.

57가 526

16

		TEL	
MODEL	TSR - 23SD/49SD, TSF - 23SD/49SD()		
BUYER			
	1	2001.10.20	6 2001.12.15
	2	2001.10.24	7 2001.12.18
	3	2001.11.2	8 2001.12.20
	4	2001.11.6	9 2001.12.27
	5	2001.12.5	10
	(2002.1.11)		
MEMO	(2001.10.24) - (4,5,11,15,16,17,18,19,21,22,24,31,32,33,35p) - 15page (2001.11.2) - (2,3,4,6,7,8,9,11,20,21,22,23p) - 12page (2001.11.6) - (2p) - 1page (2001.11.29) - (,1,4~9,11~14,17~19,21~24,28,29p) - 23page (2001.12.5) - (4,5,6p) - 3page (2001.12.15) - (2001.12.18) - (,2,4,11,12,22,24,45,46,51) - 10page (2001.12.19) - (4,11,12,22,24p) - 5page (2001.12.20) - (22p) - 1page (2001.12.27) - (11,14,15,16,18,19p) - 6page (2001.12.28) - (14,15,18p) - 3page (2001.1.2) - (15p) - 1page (2002.1.4) - (18p) - 1page (2002.1.8) - (2,3,8,21,23,24,26,27,28,29,30,31,33,) - 14page 03.2.3 - ()		

VISION

TEL: 757 - 9340 FAX: 774 - 1039