

# COMMERCIAL REFRIGERATOR INSTRUCTION MANUAL

Model No.: **TGM-22R**

## FEATURE CHART

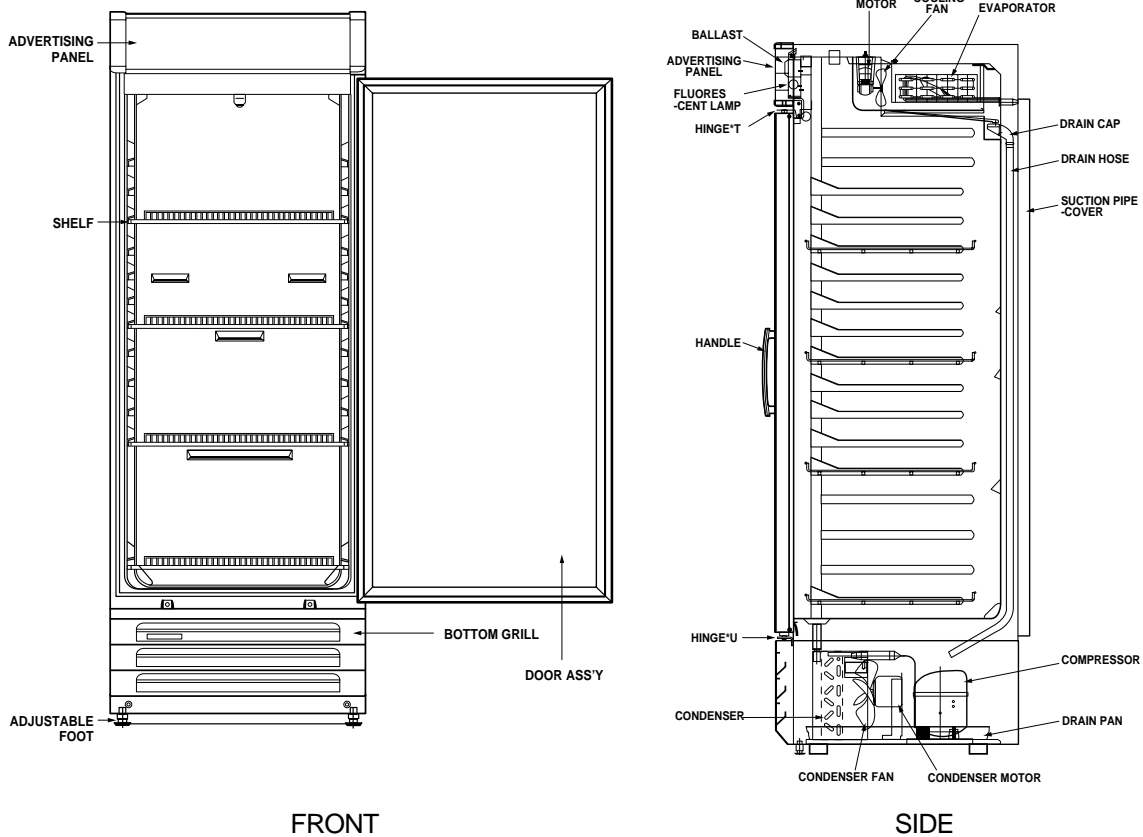

Before operating this unit, please read these instructions completely.

## HOW TO INSTALL

### ■ In good ventilation.

- Place the refrigerator in good ventilation for a good operation.

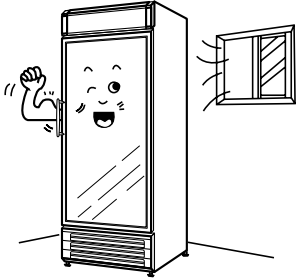

### ■ Place the refrigerator on hard and level floor.

- Unlevel floor may cause the refrigerator to make noise.

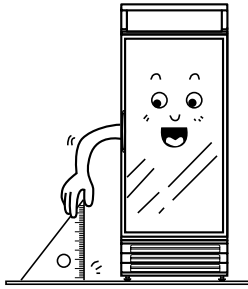

### ■ Put away heat source from the refrigerator.

- High ambient temperature will make cooling efficiency lower.

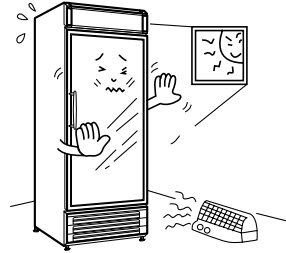

### ■ Install the refrigerator at indoor not to get wet from the rain.

- This unit is designed for indoor usage only.

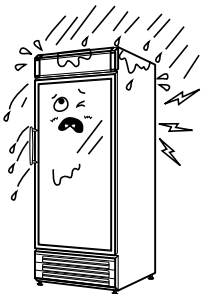

### ■ Avoid places that are exposed to smoke.

- The discoloring can occur to the refrigerator.

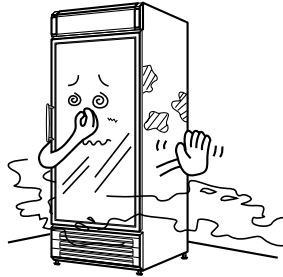

### ■ Place the refrigerator in an area with low moisture.

- Splashing water or a high moisture area may cause short circuit and make rusting easier.



### ■ Install the refrigerator on the places with 41~95°F.

- The stored materials could be frozen or broken below 41°F and cooling efficiency could be lower over 95°F.

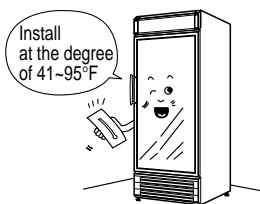

### ■ Set the front of the refrigerator a little bit higher than back-side by using adjustable feet to drain the water away easily.

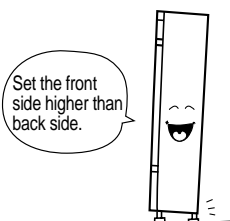

### ■ Adjust the temperature in the refrigerator.

- Controller is attached to the right on the upper.
- Set the temperature control at normal position.

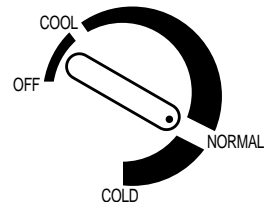

## CLEANING

### ■ Cleaning the interior and exterior

- Wash it with warm and soapy water and rinse, and dry it.
- Wipe with a dry cloth, using rinse and dry it.
- Clean the gasket frequently.
- Wash the shelf with water.
- Dewdrops in rainy-season, wipe it with a dry cloth.

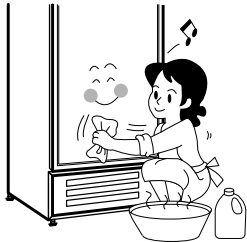

### ■ Check points after cleaning

- Check again the refrigerator for safety.
- Do not plug the power cord with wet hands.
- Check the noise or overheating.



### ■ Compressor

- Dirty stains on the condenser make cooling effect lower. At least, cleaning it twice a year using the brush or vacuum cleaner.
- Especially, be sure to clean the condenser before reoperating, after a long period of non-operation.

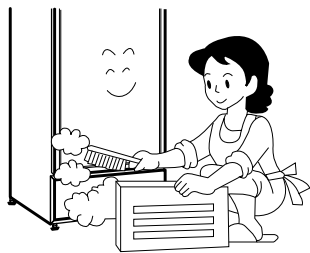

### ■ Caution

- Unplug the power cord before cleaning.
- Clean the refrigerator periodically.
- Do not use the abrasive cleaners, solvents or polishing agents on plastic parts. These cleansers may cause cracking or discoloring.

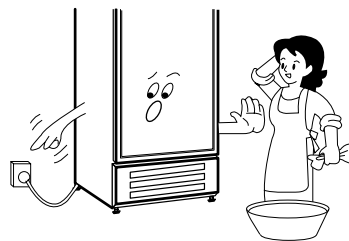

### ■ Drainage

- Take out the bottom grill to empty the tray.
- Clean it at least once in 2days.  
(in rainy season, it needs everyday.)



## CAUTION

### ■ Ventilation

- Place the refrigerator under proper ventilation
- Keep the cabinet 4" from rear wall.

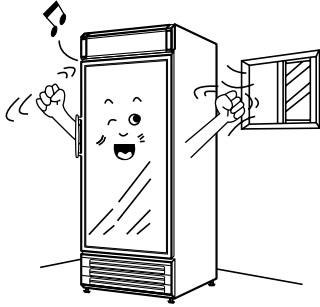

### ■ Warning

- It is the responsibility of the purchaser in case of followings.
  - Compressor under low voltage
  - Compressor more than 7 feet from plug-in connection.
  - Compressor under unstable voltage
  - Compressor not under 115V/60Hz

### ■ Start-up

- Plug the power cord into the wall outlet.
- The outlet should be only for the refrigerator.
- The temperature controller should be on normal position.
- If disconnected, shut down, wait 5 minutes before re-starting it.

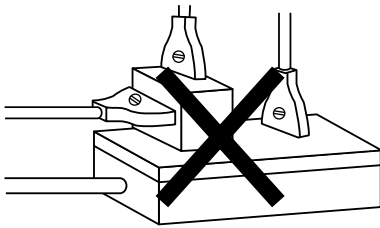

### ■ Temperature control

- To keep the temperature down : Turn the dial CW.
- To keep the temperature up : Turn the dial CCW.

### ■ Before you operate the unit.

Please unscrew the Bottom grill and take out the pad in the Drain pan.

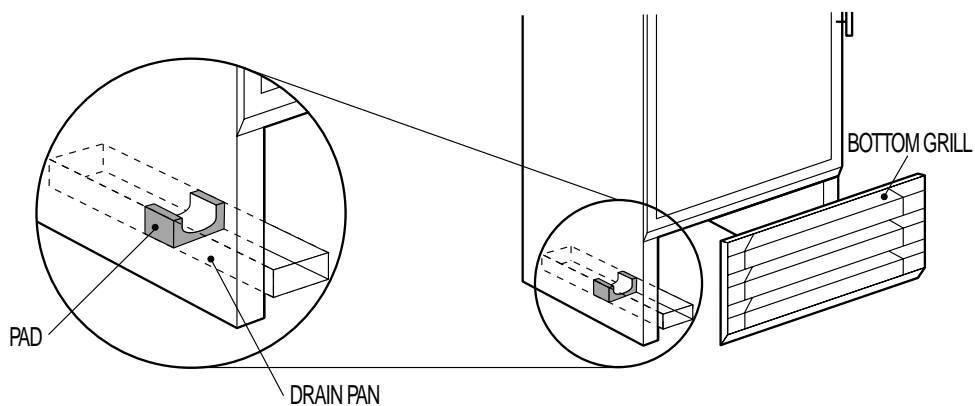

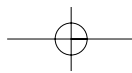

## BEFORE REQUESTING SERVICE

SYMPTOMS	CAUSES	SOLUTIONS
When food freeze.	<ul style="list-style-type: none"> <li>• Because of the differences between ambient temperature and a quantity of food stored, when the temp. dial is on the cold position.</li> </ul>	<ul style="list-style-type: none"> <li>• Turn the temp. dial to the warm position.</li> </ul>
	<ul style="list-style-type: none"> <li>• Food would freeze in ambient temperature of below 41°F and the temp. dial on the cold position.</li> </ul>	<ul style="list-style-type: none"> <li>• Turn the temp. dial to the warm position.</li> </ul>
When the refrigerator does not refrigerate at all.	<ul style="list-style-type: none"> <li>• When there is a power connection or failure problem.</li> </ul>	<ul style="list-style-type: none"> <li>• Check the power cord and plug it.</li> </ul>
When the refrigerator does not refrigerate well.	<ul style="list-style-type: none"> <li>• When the refrigerator is in sunlight or near a heating device.</li> <li>• When the refrigerator contains hot food or too much food.</li> <li>• When the refrigerator door is opened too frequently or left open long.</li> <li>• When the temp. dial is not on the correct position.</li> <li>• When the cooler vent is clogged.</li> </ul>	<ul style="list-style-type: none"> <li>• Check the installation place.</li> <li>• Check the condition of stored food.</li> <li>• Check the position of the temp. control dial.</li> </ul>
When there is a severe noise.	<ul style="list-style-type: none"> <li>• When the installation floor is weak or the adjustable feet is set incorrectly.</li> <li>• When the back-side of the refrigerator is close to the wall.</li> <li>• When the tray is not on the correct position.</li> </ul>	<ul style="list-style-type: none"> <li>• Check the installation and insert the tray correctly.</li> </ul>
When there are dewdrops on the refrigerator exterior.	<ul style="list-style-type: none"> <li>• High-moisture air can produce dewdrops during the rainy season.</li> </ul>	<ul style="list-style-type: none"> <li>• Wipe with a dry cloth.</li> </ul>
When there are dewdrops in the refrigerator interior.	<ul style="list-style-type: none"> <li>• When the refrigerator door is opened too frequently or left open long.</li> <li>• When damp food is stored.</li> </ul>	<ul style="list-style-type: none"> <li>• Keep the door closed to remove dewdrops.</li> </ul>
When the door does not close tightly.	<ul style="list-style-type: none"> <li>• When the door has a slant.</li> <li>• When the place is not level.</li> <li>• When the door gasket comes out.</li> </ul>	<ul style="list-style-type: none"> <li>• Regulate adjustable feet.</li> <li>• Install on level floor.</li> <li>• Insert the gasket.</li> </ul>

The following points are not malfunctions:

- Water-flowing sound can be heard when the compressor stops.  
This is a sound of REFRIGERANT flowing.
- When the compressor is stopped by defrosting control, it is not out of order but defrosting function.
- You can feel warm by touching the refrigerator's front.  
This is not a defect but a heater partly installed in the refrigerator.

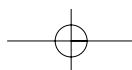

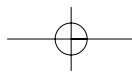

### WHAT IS NOT COVERED BY THIS WARRANTY

Turbo air's sole obligation under this warranty is limited to either repair or replacement of parts, subject to the additional limitations below. This warranty neither assumes nor authorizes any person to assume obligations other than expressly covered by this warranty.

1. WARRANTY IS NOT TRANSFERABLE. This warranty is not assignable and applies only in favor of the original purchaser/user to whom delivered. ANY SUCH ASSIGNMENT OR TRANSFER SHALL VOID THE WARRANTIES HEREIN MADE AND SHALL VOID ALL WARRANTIES, EXPRESS OR IMPLIED, INCLUDING ANY WARRANTY OF MERCHANTABILITY OR FITNESS FOR A PARTICULAR PURPOSE.
2. NO CONSEQUENTIAL DAMAGES. TURBO AIR IS NOT RESPONSIBLE FOR ECONOMIC LOSS; PROFIT LOSS OR SPECIAL, INDIRECT, OR CONSEQUENTIAL DAMAGES, INCLUDING WITHOUT LIMITATION, LOSSES OR DAMAGES ARISING FROM FOOD OR PRODUCT SPOilage CLAIMS WHETHER OR NOT ON ACCOUNT OF REFRIGERATION FAILURE.
3. ALTERATION, NEGLIGENCE, ABUSE, MISUSE, ACCIDENT, DAMAGE DURING TRANSIT OR INSTALLATION, FIRE, FLOOD, ACTS OF GOD. TURBO AIR is not responsible for the repair or replacement of any parts that Turbo Air determines have been subjected after the date of manufacture to alteration, neglect, abuse, misuse, accident, damage during transit or installation, fire, flood, or an Act of God.
4. NO IMPLIED WARRANTY OF MERCHANTABILITY OR FITNESS FOR A PARTICULAR PURPOSE. THERE ARE NO OTHER WARRANTIES, EXPRESS, IMPLIED OR STATUTORY, EXCEPT THE ONE(1) YEAR WARRANTY AND THE ADDITIONAL FOUR (4) YEAR COMPRESSOR WARRANTY AS DESCRIBED ABOVE. THESE WARRANTIES ARE EXCLUSIVE AND IN LIEU OF ALL OTHER WARRANTIES, INCLUDING IMPLIED WARRANTY AND MERCHANTABILITY OR FITNESS FOR A PARTICULAR PURPOSE. THERE ARE NO WARRANTIES WHICH EXTEND BEYOND THE DESCRIPTION ON THE FACE HEREOF.
5. TRANSPORTATION COSTS. Turbo Air will accept parts covered under this warranty freight collect, provided that shipment has received prior approval. Turbo Air is not responsible for any other transportation costs, but will ship freight collect parts either repaired or replaced under these warranties.
6. WARRANTY CLAIMS. All claims should include: model number of the cooler, the serial number of the cabinet, proof of purchase, date of installation, and all pertinent information supporting the existence of the alleged defect. Any action or breach of these warranty provisions must be commenced within one (1) year after that cause of action has accrued.

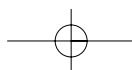

REFRIGERATOR MANUFACTURER  
**Turbo air** MANUFACTURING COMPANY

ONE YEAR WARRANTY

Turbo air warrants to the original purchaser of every new Turbo air refrigerated unit, the cabinet and all parts thereof, to be free from defects in material or workmanship, under normal use and service, for a period of one(1) year from the date of original installation or 15 months after shipment date from Turbo air , whichever occurs first.

Any parts covered by this warranty that are examined and determined by Turbo air to have been defective within one (1) year of original installation or fifteen (15) months after shipment date from manufacturer, whichever occurs first, shall be repaired or replaced as stated below. Turbo air shall be deemed to have fully complied with its obligation under the foregoing warranties by electing either one of the following procedures, at the sole discretion of Turbo air.

1. Furnishing a replacement part, freight collect, in even exchange for the returned part, freight collect.
2. Receiving the defective part, freight collect; repairing it; and returning it, freight collect.

ADDITIONAL FOUR YEAR COMPRESSOR WARRANTY

In addition to the (1) one year warranty stated above, Turbo air warrants its hermetically and semi-hermetically sealed compressor to be free from defects in both material and workmanship under normal use and service for a period of four (4) additional years from the date of original installation but not to exceed five (5) years and three (3) months after shipment from manufacturer.

Compressors determined by Turbo air have been defective within this extended time period will, at Turbo air's option, be either repaired or replaced with a compressor or compressor parts of similar design and capacity.

The for (4) year extended compressor warranty applies only to hermetically and semi-hermetically sealed parts of the compressor and does not apply to any other parts or components, including, but not limited to, cabinet, paint finish, temperature control, refrigerant, metering device, driers, motor starting equipment, fan assembly any other electrical component, etcetera.

134A COMPRESSOR WARRANTY

The four year compressor warranty detailed above will be voided if the following procedure is not carefully adhered to:

1. This system contains R134A refrigerant and polyol ester lubricant. The Polyol ester lubricant has rapid moisture absorbing qualities. If long exposure to the ambient conditions occur, the lubricant must be removed and replaced with new. Listed below are the approved lubricants for the Tecumseh compressors.

- 1 ICI-Emkarate RL 184
- 2 Emery-2927-A
- 3 Mobile Artic 22A

Failure to comply with recommended lubricant specification will void the compressor warranty.

2. Dryer replacement is very important and must be changed when a system is opened for servicing. dryer must be used with XH-9 desiccant.
3. Micron level vacuums must be achieved to insure low moisture levels in the system. 500 microns or lower must be obtained.